



BFC EC kruhové napojení

CHARAKTERISTIKA

- Radiální ventilátor s kruhovým napojením
- Pro použití v rozvodech větších délek
- Kompaktní ventilátor s vysokým výkonem a účinností, má pouze o něco větší rozměry než potrubí
- Nízká hladina akustického výkonu
- Ventilátor je určen pro dopravu čistého vzduchu bez prachu, mastnot, výparů chemikálií a dalšího znečištění
- Snadná instalace v libovolné poloze
- Pokud je ventilátor připojen na potrubí, může být instalován ve venkovním nebo vlhkém prostředí
- **Splňuje ErP 2018**

KONSTRUKCE

- Skříň ventilátoru je vyrobena z pozinkované oceli
- Oběžné kolo s dozadu zahnutými lopatkami
- Hrdla ventilátoru jsou vybavena gumovým těsněním

MOTOR

- **EC motory**
- Oběžné kolo s dozadu zahnutými lopatkami
- Vnější rotor motoru je vybaven bezúdržbovými zapouzdřenými kuličkovými ložisky
- Regulace rychlosti může být řízena vestavěným potenciometrem 0–10 V, nebo externí regulací
- Integrovaná tepelná ochrana motoru

INSTALACE

- Snadná instalace v libovolné poloze

ROZMĚRY

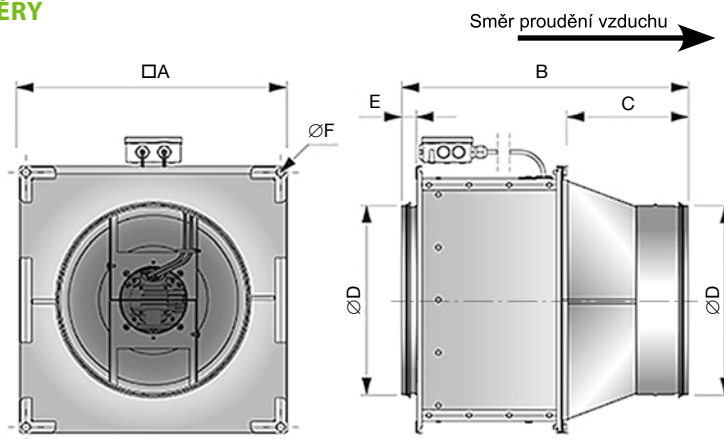

Typ	Rozměry [mm]					
	□A	B	C	∅D	E	∅F
BFC315-EC	493	595	270	315	24	9
BFC355-EC	543	654	284	355	33	9
BFC400-EC	643	788	365	400	19	9
BFC500-EC	743	867	365	500	34	9
BFC630-EC	793	796	249	630	35	9

HLUK

BFC315C1-EC	Tot	63 Hz	125 Hz	250 Hz	500 Hz	1 kHz	2 kHz	4 kHz	8 kHz
Od sání Lw dB(A)	69	52	57	61	62	59	62	59	55
Od výfuku Lw dB(A)	73	51	61	68	62	65	65	61	59
Do prostoru Lw dB(A)	52	35	37	45	48	46	42	38	34
Do prostoru Lp dB(A)	45								

BFC355B1-EC	Tot	63 Hz	125 Hz	250 Hz	500 Hz	1 kHz	2 kHz	4 kHz	8 kHz
Od sání Lw dB(A)	71	53	62	62	62	62	65	62	55
Od výfuku Lw dB(A)	72	60	63	65	60	64	66	63	57
Do prostoru Lw dB(A)	54	31	41	48	51	45	42	38	30
Do prostoru Lp dB(A)	47								

BFC355D1-EC	Tot	63 Hz	125 Hz	250 Hz	500 Hz	1 kHz	2 kHz	4 kHz	8 kHz
Od sání Lw dB(A)	72	54	62	63	63	64	66	63	58
Od výfuku Lw dB(A)	73	62	64	67	62	66	67	64	58
Do prostoru Lw dB(A)	53	35	42	48	48	46	43	39	31
Do prostoru Lp dB(A)	46								

BFC355D1-EC	Tot	63 Hz	125 Hz	250 Hz	500 Hz	1 kHz	2 kHz	4 kHz	8 kHz
Od sání Lw dB(A)	75	57	63	69	66	66	68	66	61
Od výfuku Lw dB(A)	77	65	67	69	66	70	70	67	63
Do prostoru Lw dB(A)	56	37	41	50	51	49	45	40	33
Do prostoru Lp dB(A)	49								

* Hlukové údaje měřeny v nedefinovaném prostoru ve vzdálenosti 3 m, pro statický tlak 200 Pa

** Lp: hladina akustického tlaku dB(A) ve vzdálenosti 3 m

*** Lw: hladina akustického výkonu dB(A)

BFC400B1-EC	Tot	63 Hz	125 Hz	250 Hz	500 Hz	1 kHz	2 kHz	4 kHz	8 kHz
Od sání Lw dB(A)	73	55	63	64	65	67	68	64	57
Od výfuku Lw dB(A)	79	67	70	70	71	72	72	68	62
Do prostoru Lw dB(A)	56	36	41	51	49	48	47	43	34
Do prostoru Lp dB(A)	49								

BFC400B3-EC	Tot	63 Hz	125 Hz	250 Hz	500 Hz	1 kHz	2 kHz	4 kHz	8 kHz
Od sání Lw dB(A)	79	56	65	69	68	73	74	72	63
Od výfuku Lw dB(A)	80	68	70	70	67	74	74	71	63
Do prostoru Lw dB(A)	57	36	41	50	51	50	48	44	36
Do prostoru Lp dB(A)	50								

BFC500B1-EC	Tot	63 Hz	125 Hz	250 Hz	500 Hz	1 kHz	2 kHz	4 kHz	8 kHz
Od sání Lw dB(A)	74	58	66	65	66	68	68	63	56
Od výfuku Lw dB(A)	80	69	71	67	69	76	71	67	61
Do prostoru Lw dB(A)	54	35	45	51	47	46	41	36	32
Do prostoru Lp dB(A)	47								

BFC500B3-EC	Tot	63 Hz	125 Hz	250 Hz	500 Hz	1 kHz	2 kHz	4 kHz	8 kHz
Od sání Lw dB(A)	77	60	68	68	69	71	70	66	60
Od výfuku Lw dB(A)	83	69	74	70	72	79	74	69	63
Do prostoru Lw dB(A)	56	38	46	53	50	48	43	38	34
Do prostoru Lp dB(A)	49								

BFC500D3-EC	Tot	63 Hz	125 Hz	250 Hz	500 Hz	1 kHz	2 kHz	4 kHz	8 kHz
Od sání Lw dB(A)	80	62	70	70	72	75	73	69	63
Od výfuku Lw dB(A)	86	72	75	73	76	83	78	75	68
Do prostoru Lw dB(A)	60	42	50	57	53	47	47	43	37
Do prostoru Lp dB(A)	53								

BFC630A3-EC	Tot	63 Hz	125 Hz	250 Hz	500 Hz	1 kHz	2 kHz	4 kHz	8 kHz
Od sání Lw dB(A)	76	61	66	66	66	71	69	65	60
Od výfuku Lw dB(A)	76	65	67	66	68	71	68	65	59
Do prostoru Lw dB(A)	58	37	46	55	50	49	44	38	32
Do prostoru Lp dB(A)	51								

BFC630D3-EC	Tot	63 Hz	125 Hz	250 Hz	500 Hz	1 kHz	2 kHz	4 kHz	8 kHz
Od sání Lw dB(A)	79	65	69	70	69	74	72	68	60
Od výfuku Lw dB(A)	83	74	76	75	75	75	72	67	58
Do prostoru Lw dB(A)	59	44	47	57	53	49	43	38	32
Do prostoru Lp dB(A)	52								

BFC630E3-EC	Tot	63 Hz	125 Hz	250 Hz	500 Hz	1 kHz	2 kHz	4 kHz	8 kHz
Od sání Lw dB(A)	77	63	66	65	67	72	72	68	61
Od výfuku Lw dB(A)	78	67	69	66	69	73	71	68	60
Do prostoru Lw dB(A)	60	40	49	57	42	52	47	41	34
Do prostoru Lp dB(A)	53								

BFC630F3-EC	Tot	63 Hz	125 Hz	250 Hz	500 Hz	1 kHz	2 kHz	4 kHz	8 kHz
Od sání Lw dB(A)	80	66	70	70	71	75	73	69	62
Od výfuku Lw dB(A)	85	76	81	76	77	78	74	69	60
Do prostoru Lw dB(A)	62	45	50	58	56	53	47	41	34
Do prostoru Lp dB(A)	55								

* Hlukové údaje měřeny v nedefinovaném prostoru ve vzdálenosti 3 m, pro statický tlak 200 Pa

** Lp: hladina akustického tlaku dB(A) ve vzdálenosti 3 m

*** Lw: hladina akustického výkonu dB(A)

BFC315C1-EC

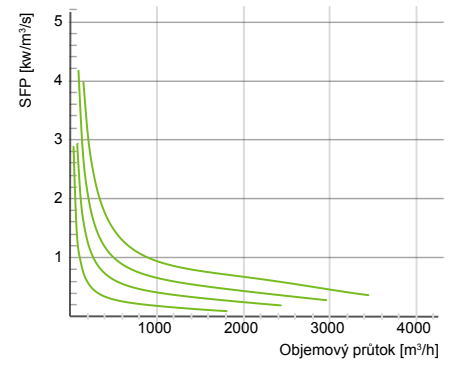
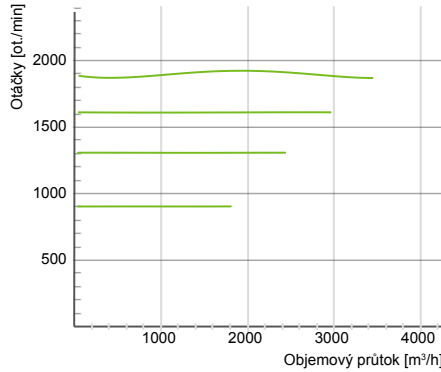
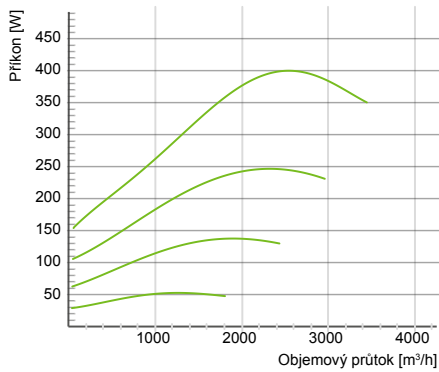
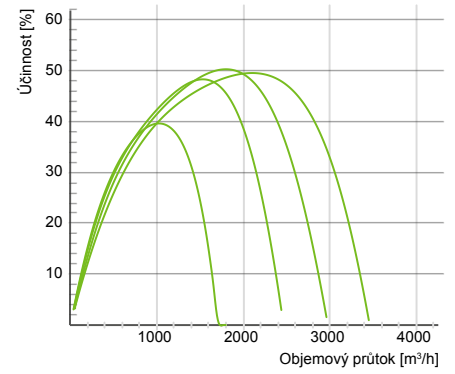
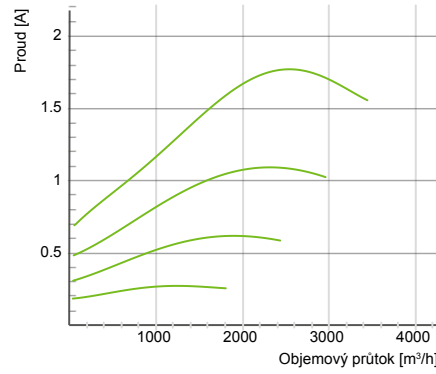
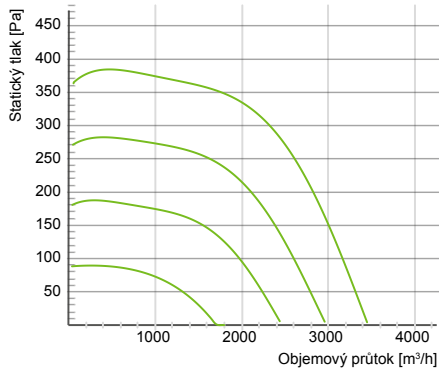

Typ	Napájení [V/Hz]	Hmotnost [kg]	Příkon [W]	Proud [A]*	IP/CL	Otáčky [ot./min]	Teplota [°C]**	Napojení [mm]	Max. průtok [m³/h]	Max. tlak [Pa]
BFC315C1-EC	230/50	17,5	408	1,81	54/F	1880	55	315	3463	385

* Proud, když je ventilátor regulován

** Maximální teplota dopraveného vzduchu, když je ventilátor regulován

BFC355B1-EC

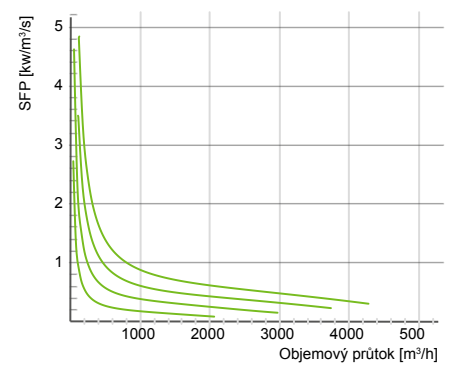
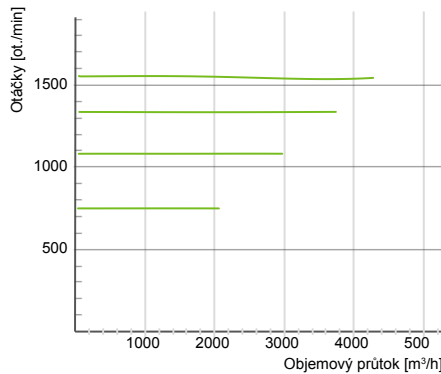
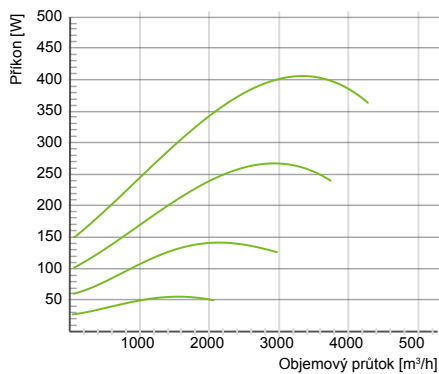
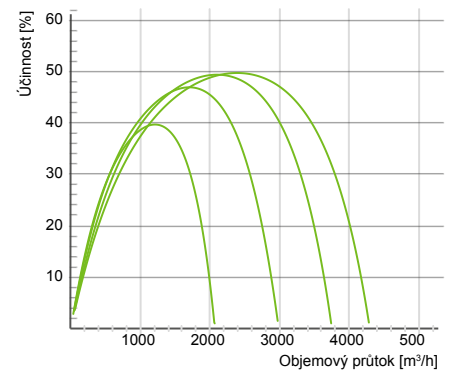
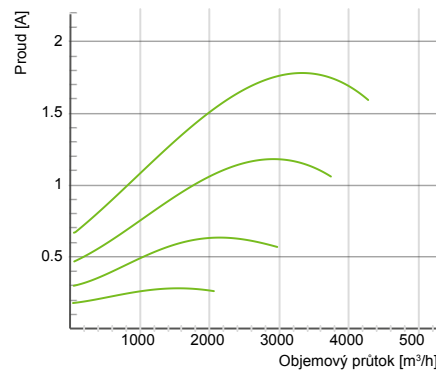
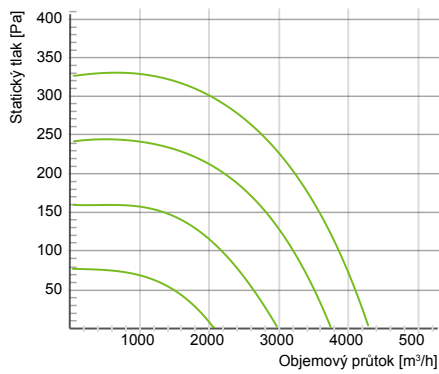

BFC355D1-EC

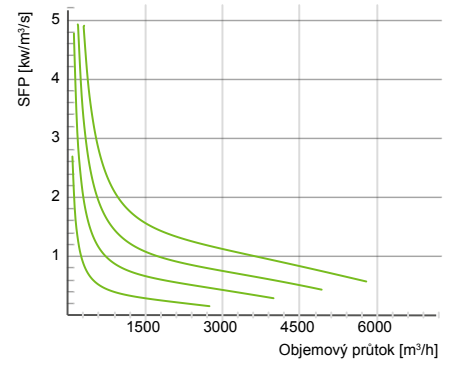
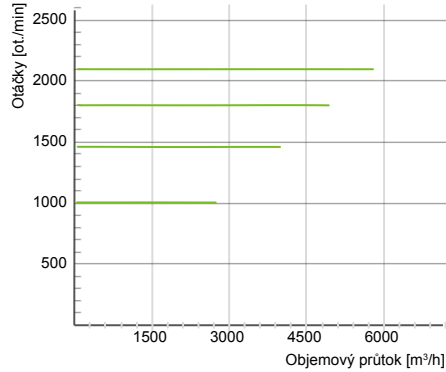
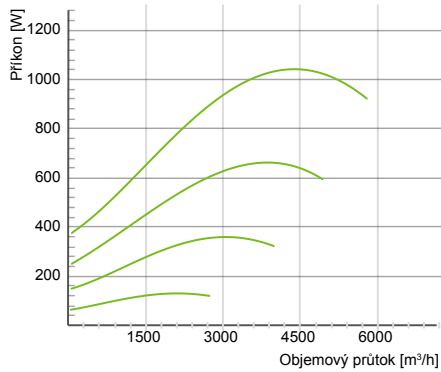
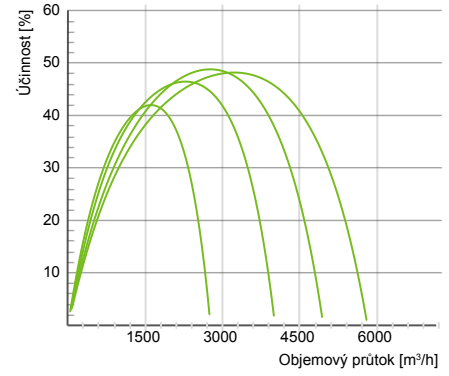
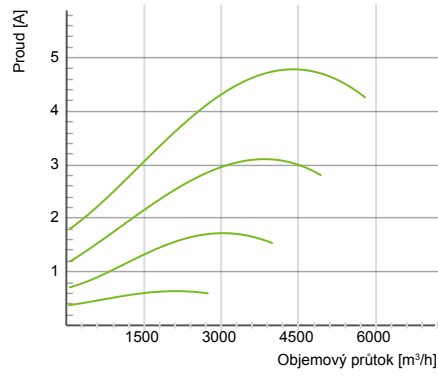
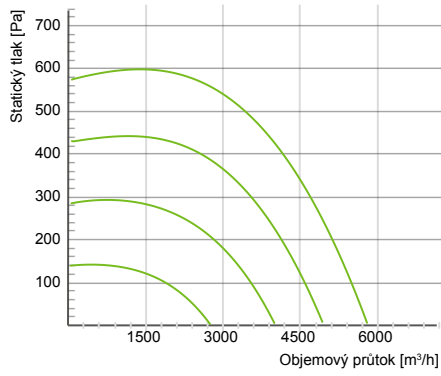

BFC355D3-EC

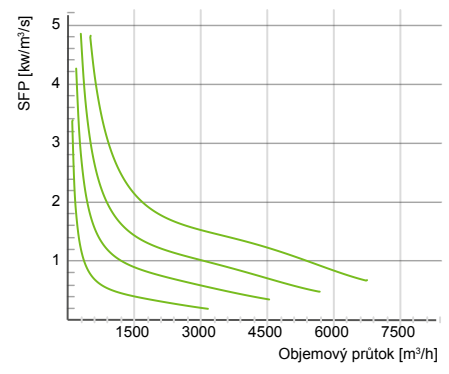
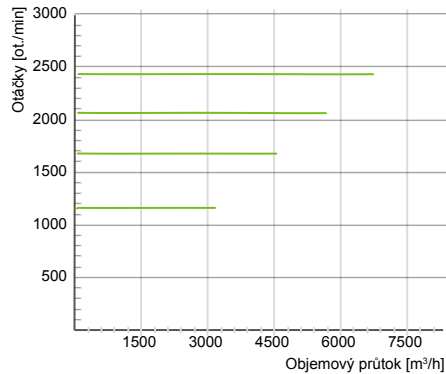
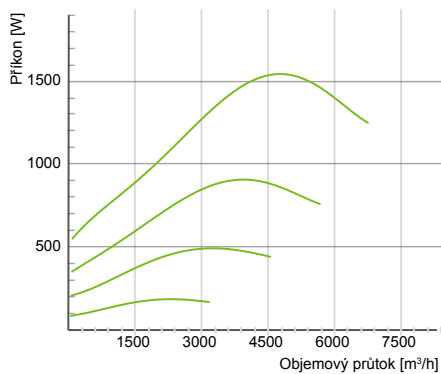
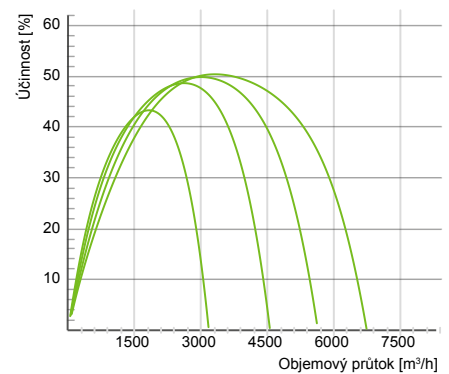
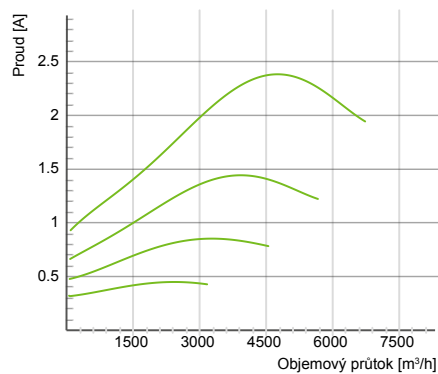
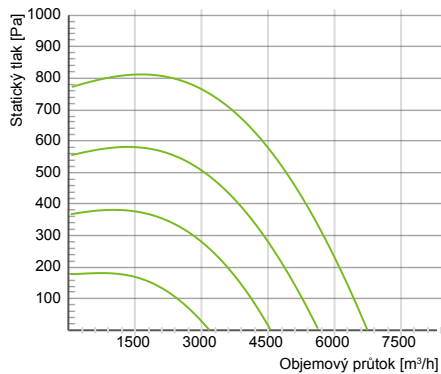

Typ	Napájení [V/Hz]	Hmotnost [kg]	Příkon [W]	Proud [A]*	IP/CL	Otáčky [ot./min]	Teplota [°C]**	Napojení [mm]	Max. průtok [m³/h]	Max. tlak [Pa]
BFC355B1-EC	230/50	24,1	406	1,77	54/F	1530	55	355	4298	334
BFC355D1-EC	230/50	24,1	1040	4,81	54/F	2100	55	355	5810	604
BFC355D3-EC	400/50	24,1	1540	2,38	54/F	2430	55	355	6743	812

* Proud, když je ventilátor regulován

** Maximální teplota dopravovaného vzduchu, když je ventilátor regulován

BFC400B1-EC

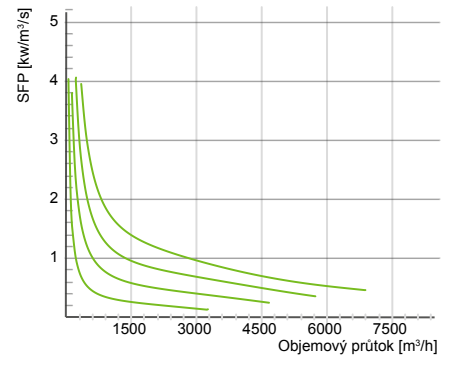
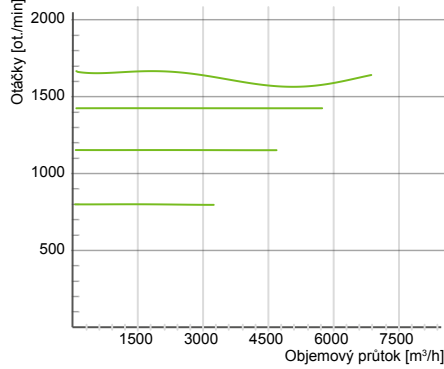
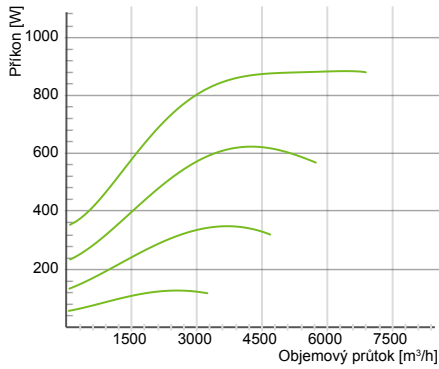
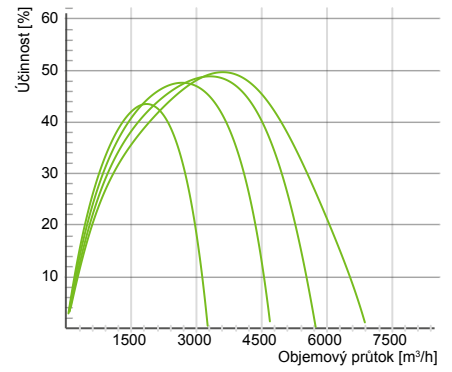
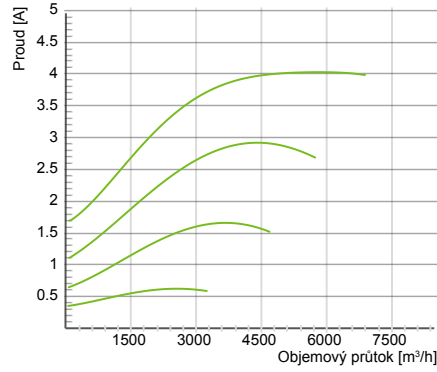
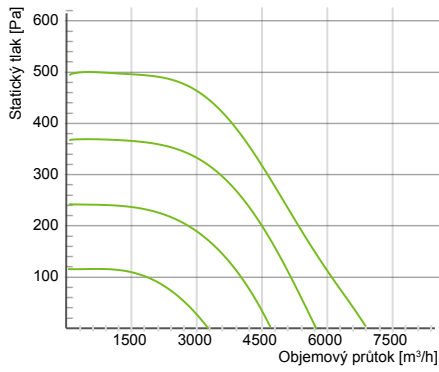

BFC400B3-EC

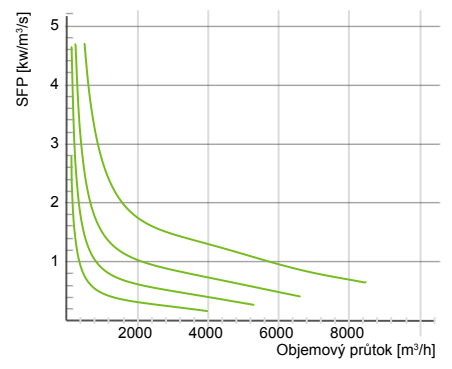
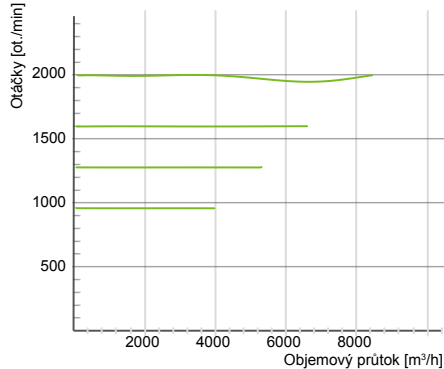
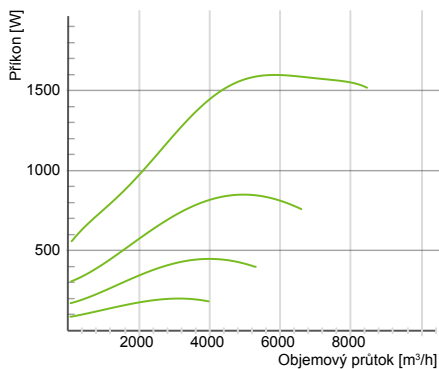
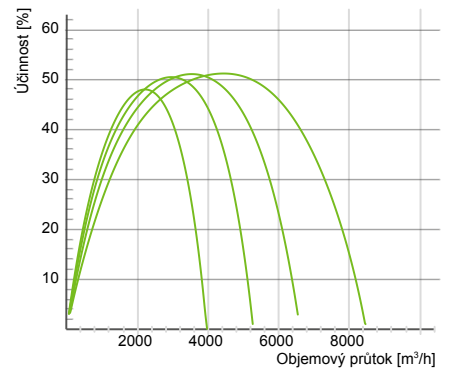
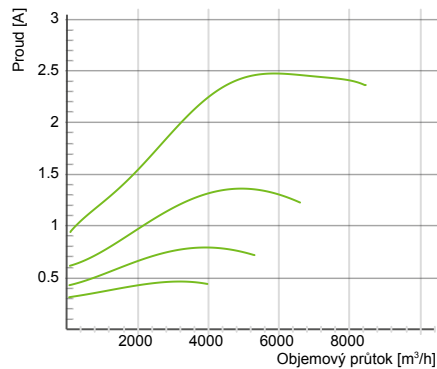
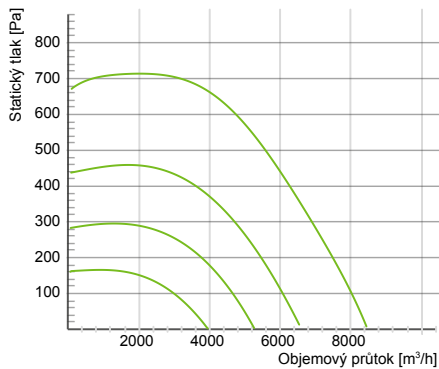

Typ	Napájení [V/Hz]	Hmotnost [kg]	Příkon [W]	Proud [A]*	IP/CL	Otáčky [ot./min]	Teplota [°C]**	Napojení [mm]	Max. průtok [m³/h]	Max. tlak [Pa]
BFC400B1-EC	230/50	35,9	896	4,04	54/F	1640	55	400	6833	506
BFC400B3-EC	400/50	35	1590	2,45	54/F	1990	50	400	8474	713

* Proud, když je ventilátor regulován

** Maximální teplota dopravovaného vzduchu, když je ventilátor regulován

BFC500B1-EC

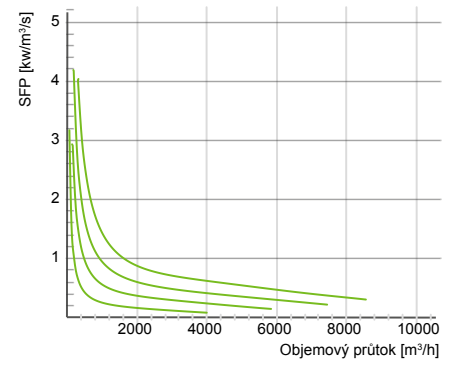
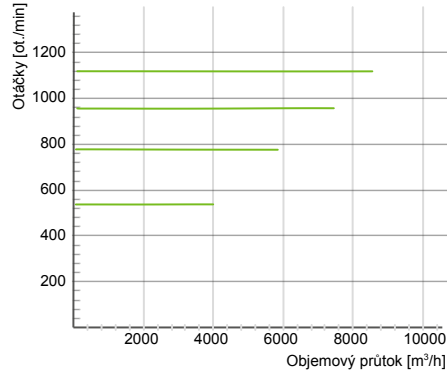
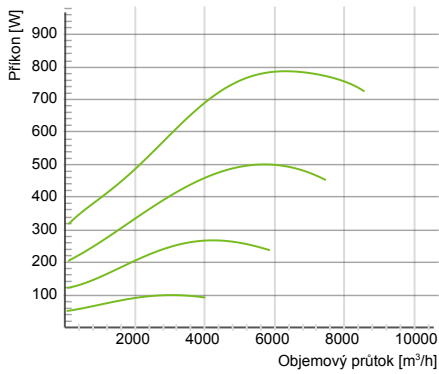
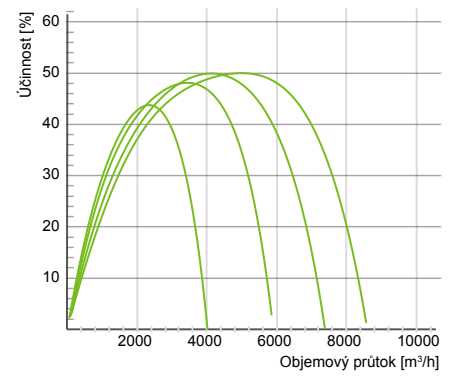
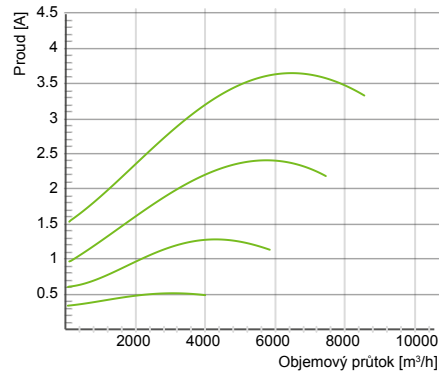
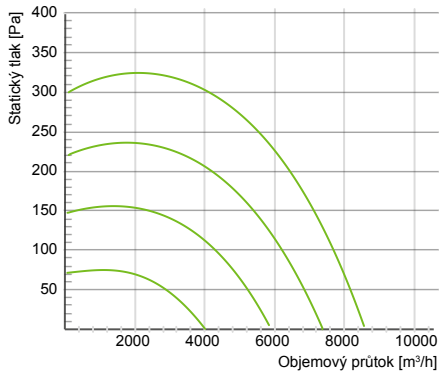

BFC500B3-EC

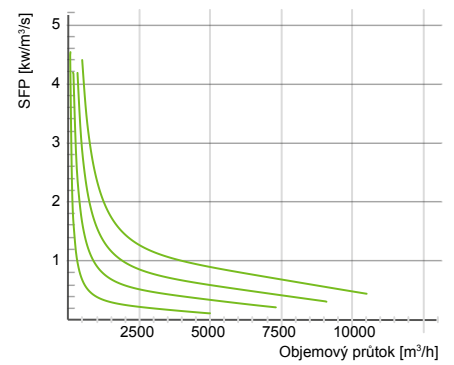
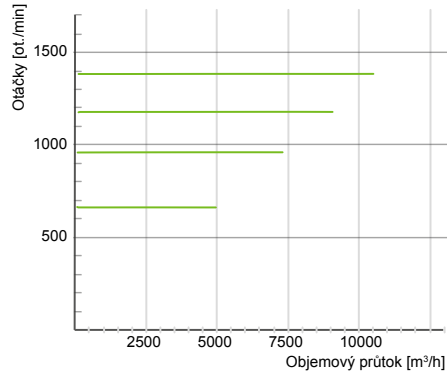
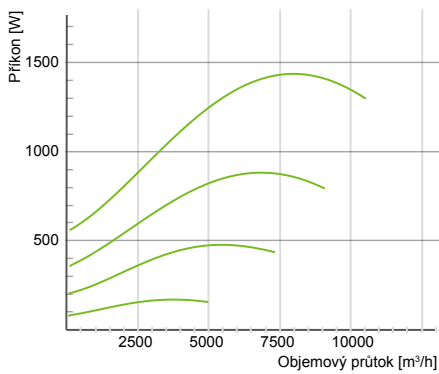
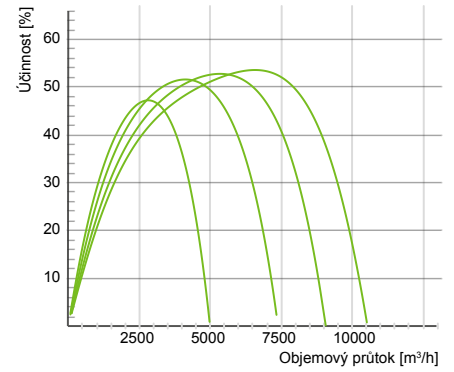
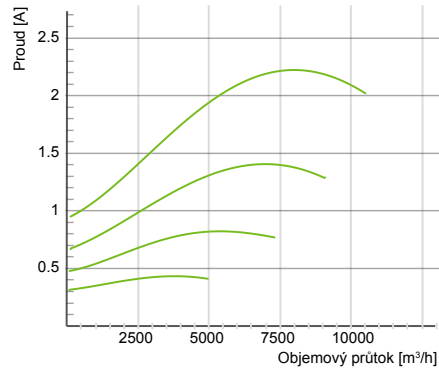
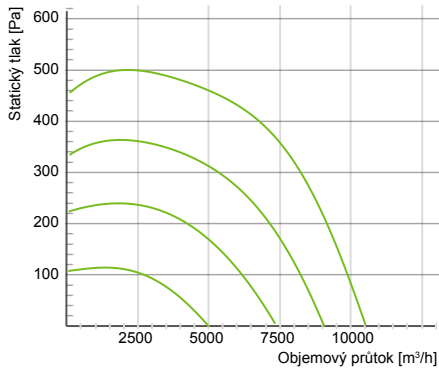

BFC500D3-EC

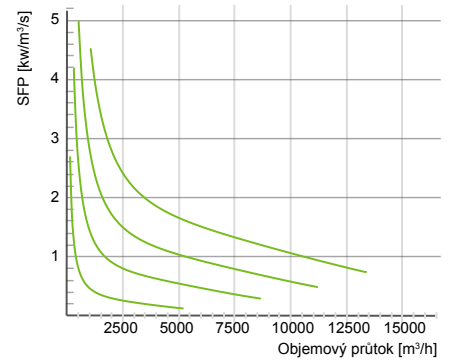
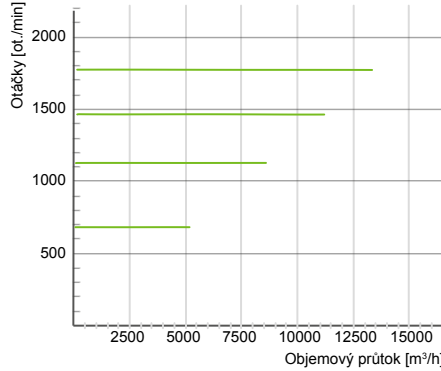
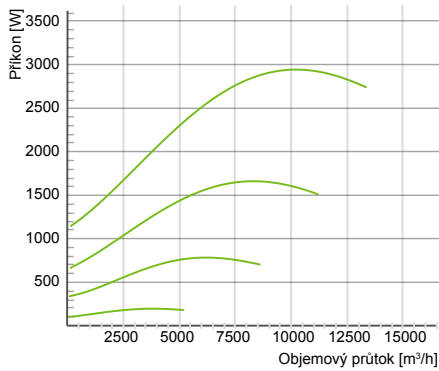
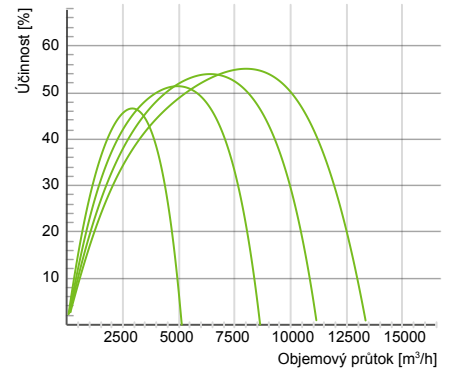
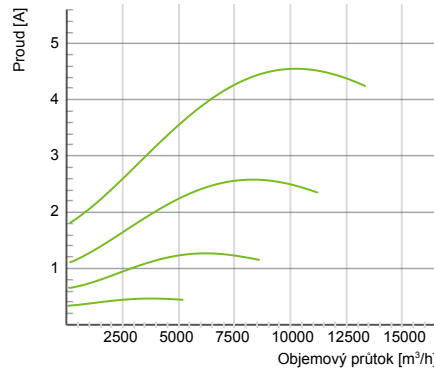
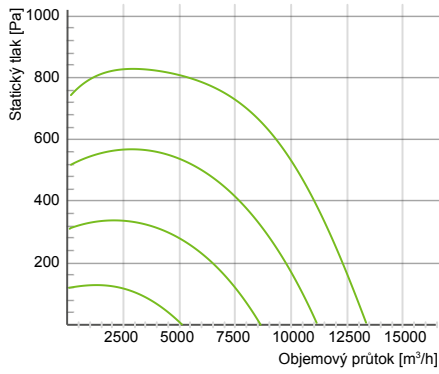

Typ	Napájení [V/Hz]	Hmotnost [kg]	Příkon [W]	Proud [A]*	IP/GL	Otáčky [ot./min]	Teplota [°C]**	Napojení [mm]	Max. průtok [m³/h]	Max. tlak [Pa]
BFC500B1-EC	230/50	58,9	784	3,62	54/F	1120	55	500	8597	326
BFC500B3-EC	400/50	51,2	1450	2,24	54/F	1380	40	500	10541	499
BFC500D3-EC	400/50	55	2940	4,54	54/F	1770	60	500	13381	828

* Proud, když je ventilátor regulován

** Maximální teplota dopravaného vzduchu, když je ventilátor regulován

BFC630A3-EC

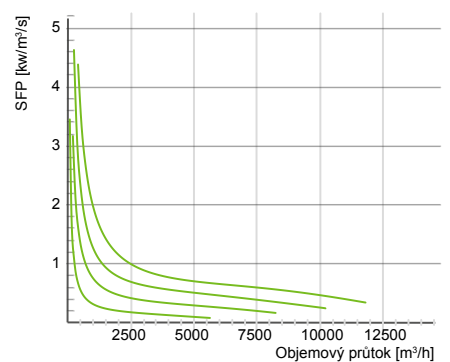
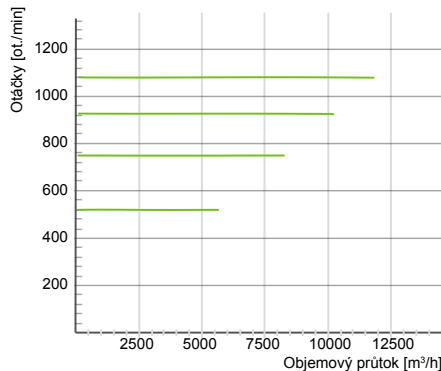
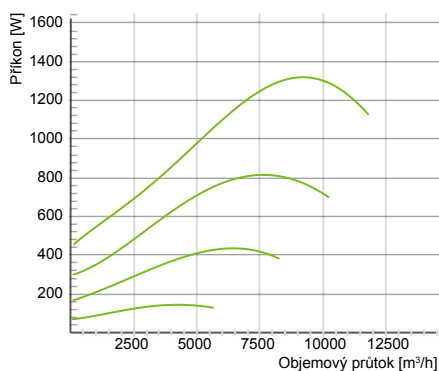
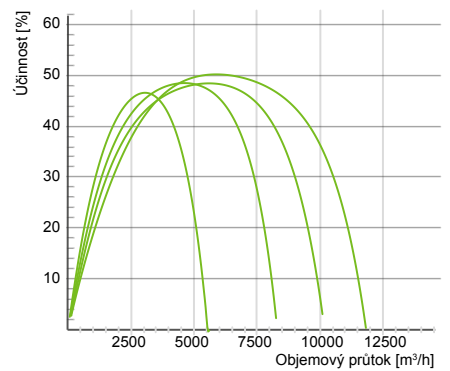
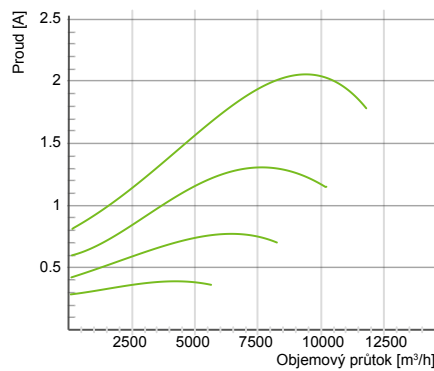
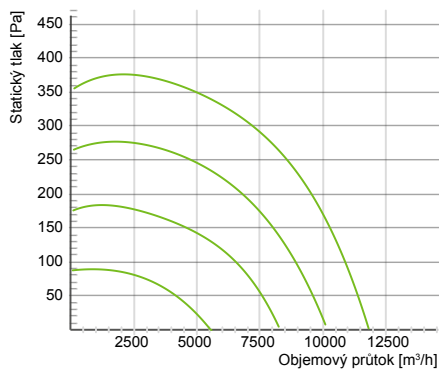

BFC630D3-EC

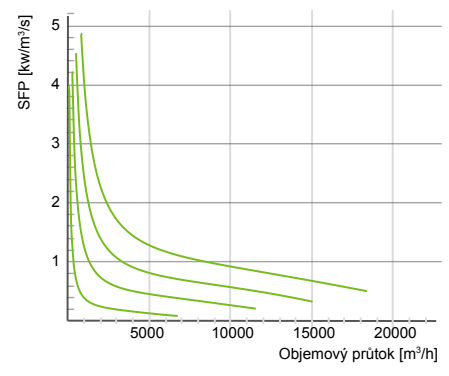
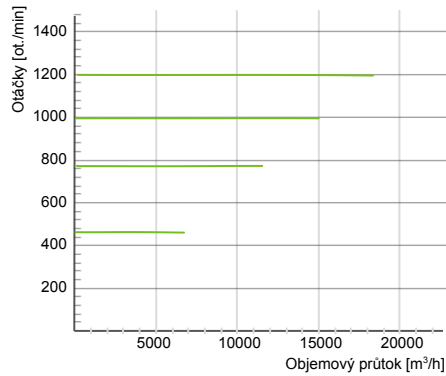
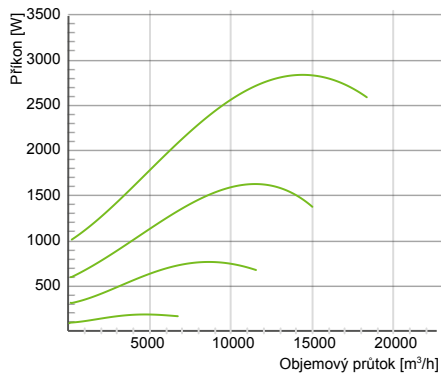
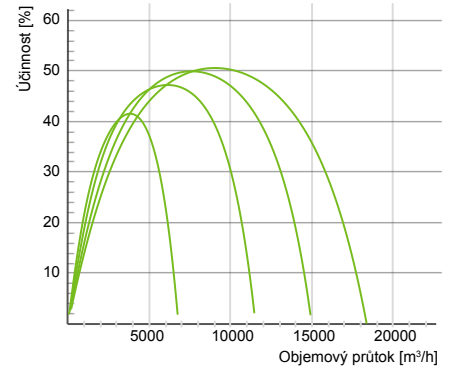
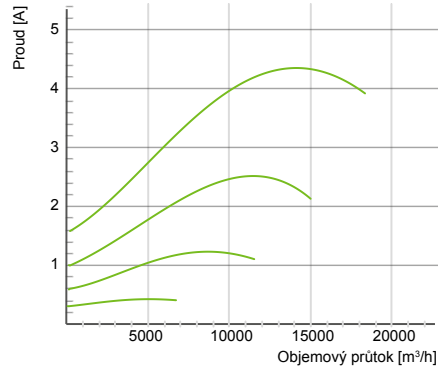
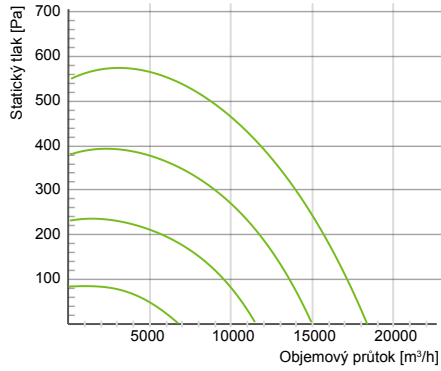

BFC630E3-EC

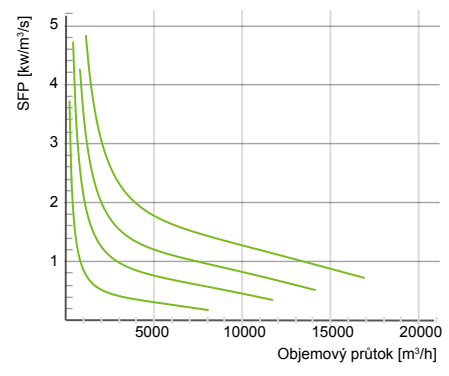
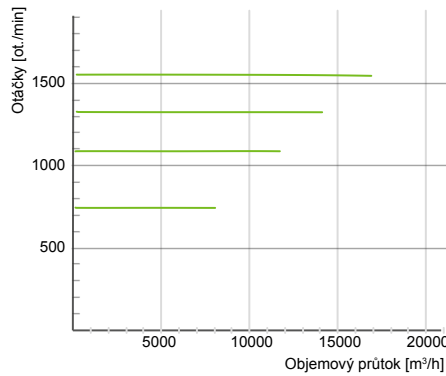
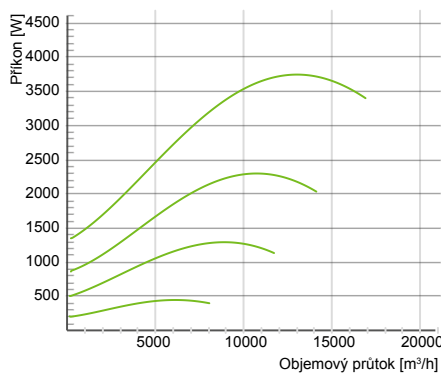
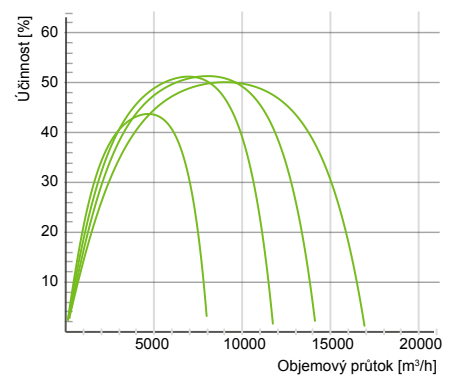
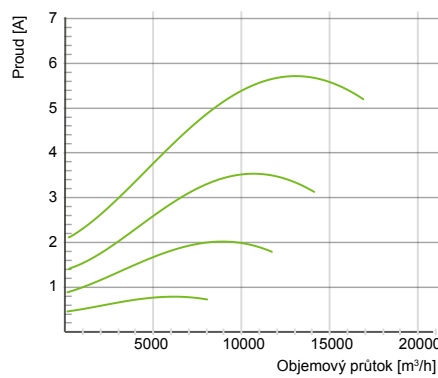
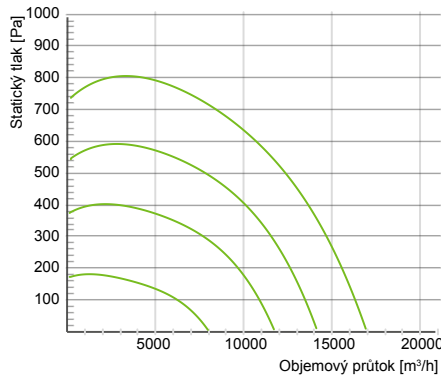

3

BFC630F3-EC

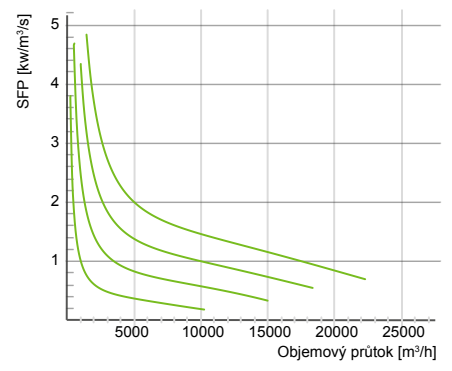
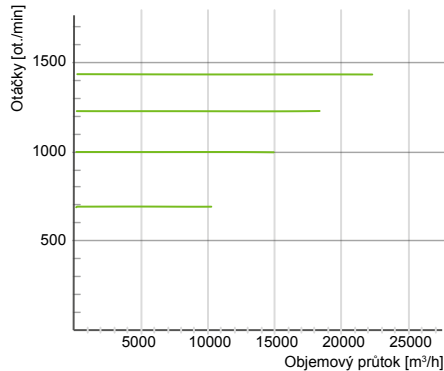
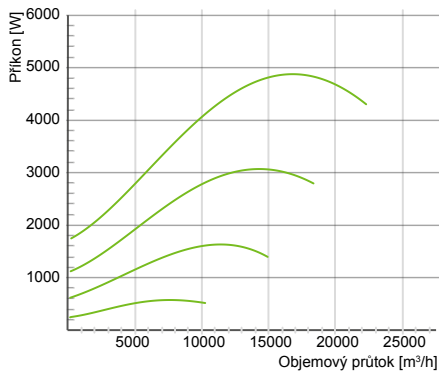
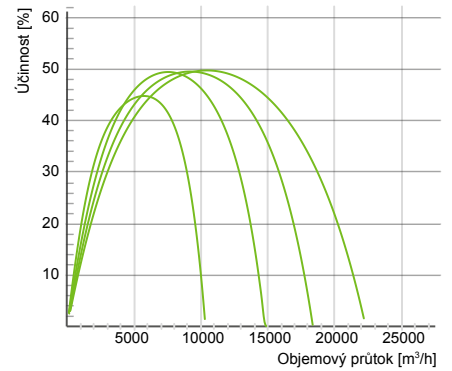
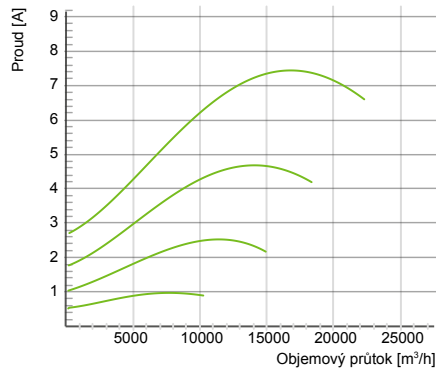
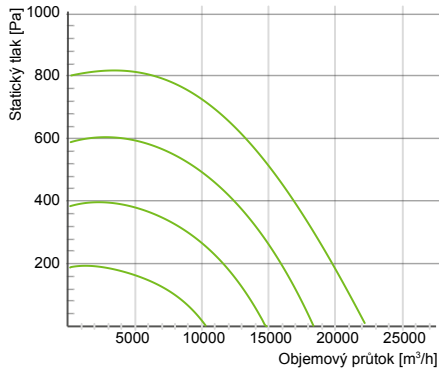

Typ	Napájení [V/Hz]	Hmotnost [kg]	Příkon [W]	Proud [A]*	IP/CL	Otáčky [ot./min]	Teplota [°C]**	Napojení [mm]	Max. průtok [m³/h]	Max. tlak [Pa]
BFC630A3-EC	400/50	59,3	1320	2,05	54/F	1080	40	630	11830	380
BFC630D3-EC	400/50	86,4	2820	4,35	54/F	1200	60	630	18364	578
BFC630E3-EC	400/50	59,5	3730	5,7	54/F	1550	50	630	16974	801
BFC630F3-EC	400/50	86,4	4800	7,3	54/F	1430	40	630	22313	826

* Proud, když je ventilátor regulován

** Maximální teplota dopravovaného vzduchu, když je ventilátor regulován

PŘÍSLUŠENSTVÍ REGULACE

Typ	Regulace
BFC315B1-EC	MS EC
BFC315C1-EC	MS EC
BFC355B1-EC	MS EC
BFC355D1-EC	MS EC
BFC355D3-EC	MS EC
BFC400B1-EC	MS EC
BFC400B3-EC	MS EC
BFC500B1-EC	MS EC
BFC500B3-EC	MS EC
BFC500D3-EC	MS EC
BFC630A3-EC	MS EC
BFC630D3-EC	MS EC
BFC630E3-EC	MS EC
BFC630F3-EC	MS EC

MS EC – Manuální třírychlostní regulátor otáček EC motorů, 0–10 V. Min–max lze nastavit pomocí šroubů pod knoflíkem



SCHEMA ZAPOJENÍ

BFS400400B1-EC

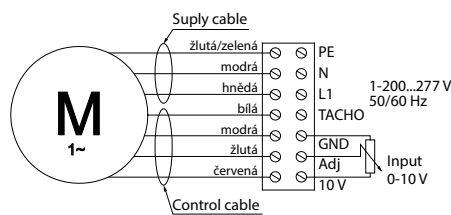

BFS450450C1-EC, BFS500500B1-EC

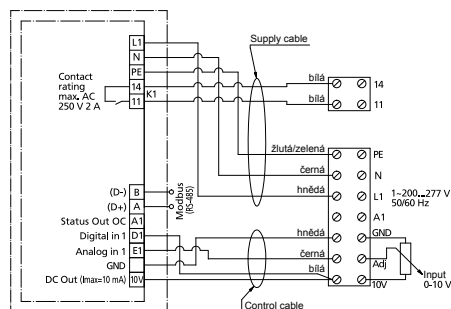

* Uvedená schémata zapojení jsou pouze orientační, vždy má vyšší prioritu schéma zapojení uvedené na výrobku

BFS500500D1-EC, BFS600600B1-EC, BFS700700B1-EC

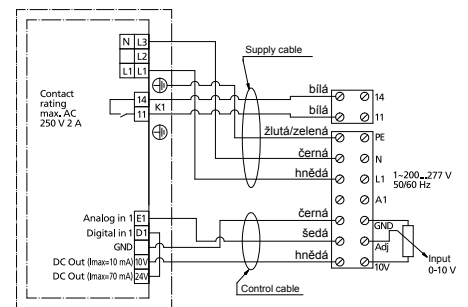

BFS500500D3-EC, BFS600600B3-EC, BFS700700B3-EC, BFS750750A3-EC, BFS750750E3-EC, BFS850850D3-EC, BFS850850F3-EC

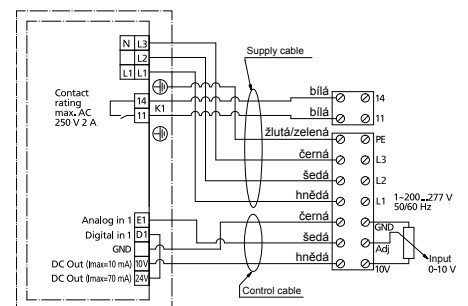

PŘÍSLUŠENSTVÍ KOMONENTY



FLF-A
Kapsový filtrační box



FLK-B
Deskový filtrační box

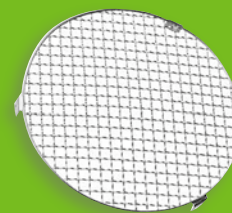

BSV
Krycí mřížka



MK
Pružná manžeta



YG
Kruhová hliníková krycí mřížka

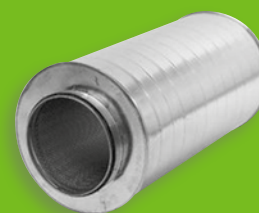

SPT-GLX
Kruhový tlumič hluku

PŘÍKLAD ZNAČENÍ

BFC315B1-EC

- EC** – motor
- 1** – 1f 230 V
- 3** – 3f 400 V
- B** – Výkonová řada
- 315** – Jmenovitý průměr
- BFC** – Radiální potrubní ventilátor, vysoký výkon